

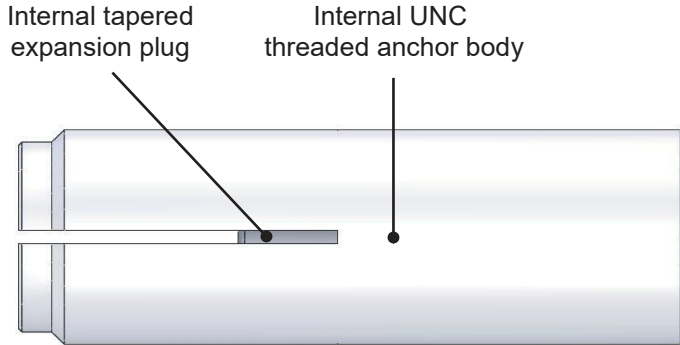

# DROP-IN (DI) ANCHOR TECHNICAL MANUAL

# DROP-IN (DI) ANCHOR



## DESCRIPTION

The DI Proton anchor is an internally threaded carbon steel anchor, pre-assembled with an internal expansion plug. These anchors are used in solid concrete, concrete blocks and hard stone.

The DI Proton Anchor System is designed for an easier, faster, more secure, full anchor setting.

## FEATURES

- Pre-assembled design
- Corrosion-resistant
- Flush DI Anchor Applications
- Visual indication for a properly set anchor
- Faster and safer installation

## LIMITATIONS

Recommended for cured concrete only (at least 10 days old). Do not use on uncured concrete, light weight concrete brick, or masonry block.

## MATERIAL SPECIFICATIONS

Anchor Component	Specification
Anchor body	Carbon steel
Expansion plug	Carbon steel

**Note:** Zinc-plated carbon steel, ASTM B 633  
 SC1 Type III (Fe/Zn 5)

## TYPICAL APPLICATIONS

- Sprinkler systems
- Pipe supports
- Cable trays and strut
- Concrete formwork
- Pre-cast wall inserts
- Suspended lighting

## APPROVALS/LISTINGS

- FM (Factory Mutual)
- UL LLC



## ANCHOR SELECTION

Size	Part Number	Thread Size	Thread Depth	Drill (hole) dia.	Anchor Length	Approvals
1/4"	DI-0014-1	1/4"-20 UNC	7/16"	3/8"	1"	-
3/8"	DI-0012-1	3/8"-16 UNC	5/8"	1/2"	1-9/16"	FM/UL
1/2"	DI-0058-1	1/2"-13 UNC	3/4"	5/8"	2"	FM/UL

## INSTALLATION SPECIFICATIONS

### Manual Installation

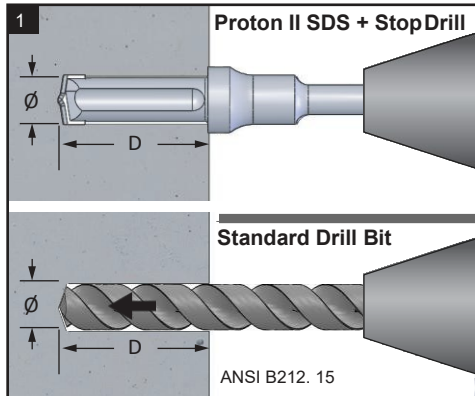

Drill hole into the base material to the depth of embedment required, using a Proton SDS + Stop Drill, or a standard drill bit.

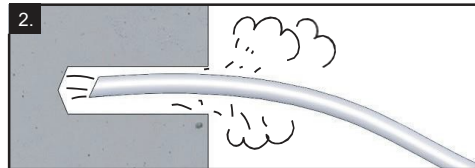

Clean the hole with compressed air or a proper dust removal tool to make sure there is no residual dust inside.

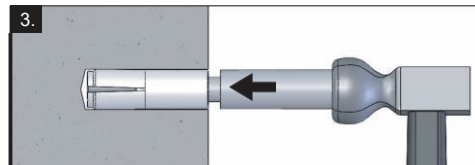

**!** Proton Manual Setting Tool must be used to set the anchor by driving the tool with a sufficient number of hammer blows.

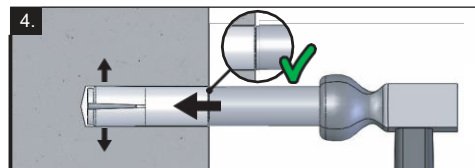

The anchor is set when the bottom of the setting tool makes full contact with the top surface of the anchor. Details on figure 5.

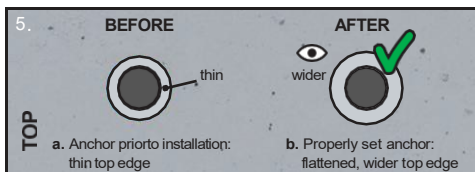

**WARNING:** Check that the anchor is properly set - the top edge of the anchor will become wider and flatter as a result of a setting mark of a properly set anchor. If the anchor has not been set properly repeat steps 1 to 4.

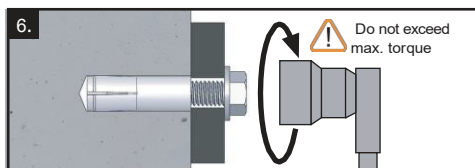

Position fixture, insert bolt and tighten until the tread engages properly. Refer to Installation Specification table for proper torque value (p.3).

### Installation Using Proton SCX Drilling and Anchoring System

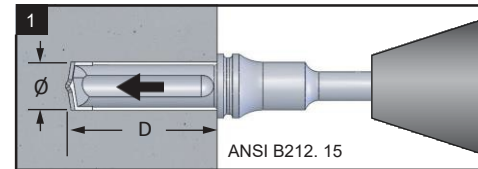

Drill hole into the base material to the depth of embedment required.

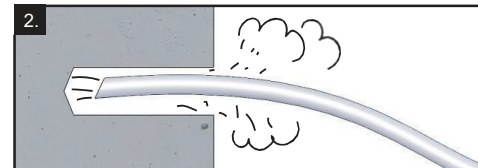

Clean the hole with compressed air or a proper dust removal tool to make sure there is no residual dust inside.

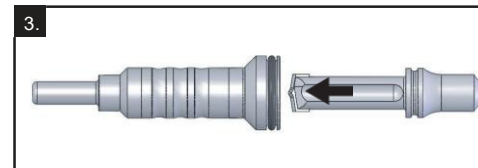

Connect the Proton Snap Fit Setting Tool to the Proton SCX Stop Drill.

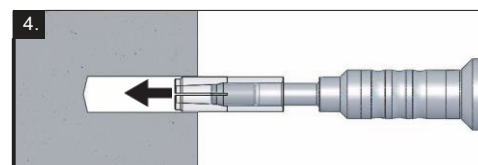

**!** Proton Snap Fit Setting Tool must be used to expand the anchor.

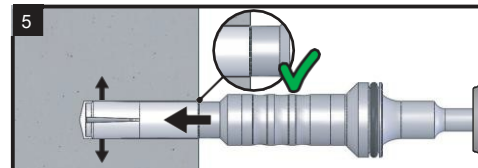

The anchor is set when the bottom of the setting tool makes full contact with the top surface of the anchor. Details on figure 6.

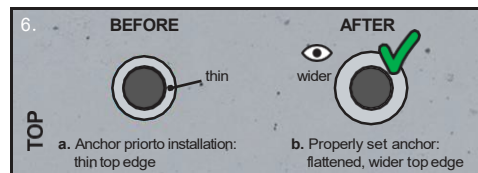

**WARNING:** Check that the anchor is properly set - the top edge of the anchor will become wider and flatter as a result of a setting mark of a properly set anchor. If the anchor has not been set properly repeat steps 1 to 5.

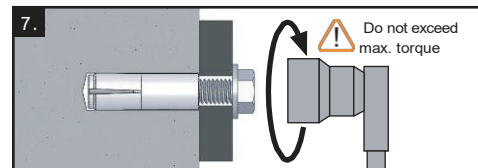

Position fixture, insert bolt and tighten until the tread engages properly. Refer to Installation Specification table for proper torque value (p.3).

**INSTALLATION SPECIFICATIONS**

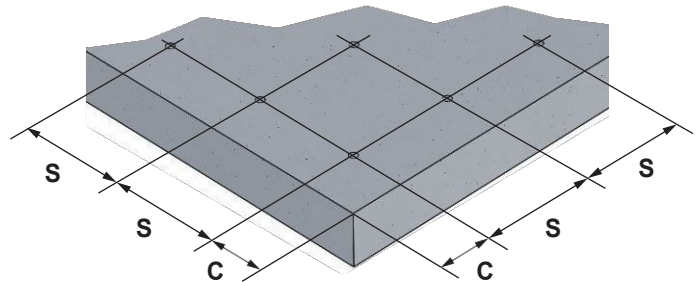
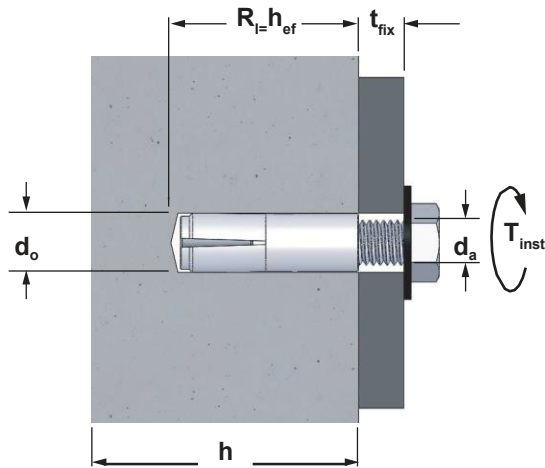

Details	Anchor size (inch)		
	1/4	3/8	1/2
Anchor size/internal thread diameter $d_a$ (inch)	0.250	0.375	0.500
Drill bit/hole nominal diameter $d_o$ (inch)	0.375	0.500	0.625
Effective embedment/hole depth $h_{ef}/h_i$ (inch)	1	1-9/16	2
Critical anchor spacing for 100% performance $s_{cr}$ (inch)	3-1/2	5-1/2	7
Minimum anchor spacing for 50% performance $s_{min}$ (inch)	2	3	4
Critical edge distance for 100% performance $c_{cr}$ (inch)	3	4-1/2	6
Minimum edge distance $c_{min}$ (inch)	2	3	4
Minimum base material thickness $h$ (inch)	3	3-1/2	4
Maximum installation torque $T_{inst}$ (ft x lbf)	4	11	22
Usable thread length (inch)	7/16	5/8	3/4

**Notes:**

- Carbide tipped drill bits shall conform to ANSIB 212.15.
- Do not exceed the maximum installation torque.

**RECOMMENDED SDS+ ROTARY HAMMER DRILL SPECIFICATIONS**

Anchor size (inch)	Concrete Compressive Strength(psi)	Rated Tool Impact Energy - Suggested Range (ft•lbf)	Recommended Rotary Hammer Tool Model Number	
			Milwaukee Cordless / Power	Bosh
3/8	2500	2.6 - 3.1	2715-22 M18 1-1/8"	RH328VC 1-1/8"
	6000	2.6 - 3.3	2715-22 M18 1-1/8"	RH328VC 1-1/8"
1/2	2500	3.1 - 3.3	5268-21 M28 Fuel 1-1/8"	RH328VC 1-1/4"
	6000	3.1 - 3.3	5268-21 M28 Fuel 1-1/8"	RH328VC 1-1/4"

**Notes:** The above rotary hammer tools are a suggestion. Use of other equivalent rotary hammer tools is acceptable. Local concrete conditions and rotary hammer impact efficiency vary greatly. Please verify that the tool impact energy is sufficient to fully set the internal plug of the Proton drop-in anchor prior using the system.

**DESIGN DATA**

**ALLOWABLE AND ULTIMATE LOADS**  
**Normal weight stone aggregate concrete**

Anchor size (inch)	Embedment (inch)	2500 psi (17.2 Mpa)				4000 psi (27.5 Mpa)				6000 psi (41.3 Mpa)			
		Tension		Shear		Tension		Shear		Tension		Shear	
		Ultimate lbs (kN)	Allowable lbs (kN)	Ultimate lbs (kN)	Allowable lbs (kN)	Ultimate lbs (kN)	Allowable lbs (kN)	Ultimate lbs (kN)	Allowable lbs (kN)	Ultimate lbs (kN)	Allowable lbs (kN)	Ultimate lbs (kN)	Allowable lbs (kN)
1/4	1	1830 (8.2)	450 (2.0)	2070 (9.2)	510 (2.3)	2290 (10.2)	570 (2.6)	1130 (5.1)	280 (1.3)	2920 (13.0)	730 (3.3)	1450 (6.5)	360 (1.6)
3/8	1-9/16	3980 (17.7)	990 (4.4)	4780 (21.3)	1190 (5.3)	5320 (23.7)	1330 (5.9)	5420 (24.1)	1350 (6.0)	6780 (30.2)	1690 (7.5)	6910 (30.8)	1720 (7.7)
1/2	2	4370 (19.4)	1090 (4.9)	5380 (23.9)	1340 (6.0)	6690 (29.8)	1670 (7.4)	7840 (34.9)	1960 (8.7)	8530 (38.0)	2130 (9.5)	10000 (44.5)	2500 (11.1)

**Notes:** The allowable and ultimate shear values are based on the use of SAE Grade 5 (Fu=120ksi) bolts.

**LOAD ADJUSTMENT FACTORS FOR NORMAL-WEIGHT CONCRETE**  
**Tension & Shear Loads**

This equation for combining tension and shear loads must be used when anchors are subject to both tension and shear loading.

$$(F_a/F_t)^{5/3} + (V_a/V_s)^{5/3} \leq 1$$

F <sub>a</sub> = applied tension load	V <sub>a</sub> = applied shear load
F <sub>t</sub> = allowable tension load	V <sub>s</sub> = allowable shear load

Load Adjustment Factors for Anchor Spacing			
Tension and Shear Loads			
Spacing (s) (inches)	Anchor size (inches)		
	1/4	3/8	1/2
2.0	0.50		
2.5	0.67		
3.0	0.83	0.50	
3.5	1.00	0.58	
4.0		0.69	0.50
4.5		0.79	0.58
5.0		0.90	0.67
5.5		1.00	0.75
6.0			0.83
6.5			0.92
7.0			1.00

**Note:** For structural lightweight concrete, edge and spacing distances must be increased by a factor of 1.333.

Ultimate load capacities must be reduced by a minimum safety factor of 4.0 or greater to determine allowable working load.

Load Adjustment Factors for Edge Distance						
Edge Distance (c) (inches)	Tension Loads			Shear Loads		
	Anchor size (inches)			Anchor size (inches)		
	1/4	3/8	1/2	1/4	3/8	1/2
2.0	0.80			0.65		
2.5	0.90			0.83		
3.0	1.00	0.80		1.00	0.65	
3.5		0.87			0.77	
4.0		0.94	0.80		0.89	0.65
4.5		1.00	0.85		1.00	0.74
5.0			0.90			0.83
5.5			0.95			0.91
6.0			1.00			1.00

**Notes:** Allowable load values found in the performance data tables are multiplied by reduction factors when anchor spacing or edge distances are less than critical distances. Linear interpolation is allowed for intermediate anchor spacing and edge distances between critical and minimum distances. When an anchor is affected by both reduced spacing and edge distance, the spacing and edge reduction factors must be combined (multiplied). Multiple reduction factors for anchor spacing and edge distance may be required depending on the anchor group configuration.

**PRODUCT DATA**

**Proton SDS + Stop Drill Snap Fit Setting Tool: Full Kit**

SKU Model #	Anchor Rod Size	Setting Tool	Drill bit diameter	Setting Pin Length	Quantity	
					Box	Carton
554035	3/8"	3/8"	1/2"	21/32"	1	20
554042	1/2"	1/2"	5/8"	1-7/32"	1	20

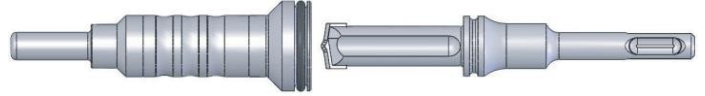

**Proton Snap Fit Setting Tool Only**

SKU Model #	Anchor Rod Size	Setting Tool	Setting Pin Length	Quantity	
				Box	Carton
554059	3/8"	3/8"	21/32"	1	20
554066	1/2"	1/2"	1-7/32"	1	20



**Proton Hand Setting Tool**

SKU Model #	Anchor Rod Size	Setting Tool	Setting Pin Length	Quantity	
				Box	Carton
554141	1/4"	1/4"	19/32"	1	20
554158	3/8"	3/8"	21/32"	1	20
554165	1/2"	1/2"	1-7/32"	1	20

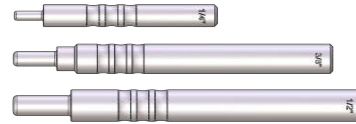

**Proton SDS + Stop Drill (SCX)**

SKU Model #	Drill bit diameter	Quantity	
		Box	Carton
554073	1/2"	1	20
	5/8"	1	20

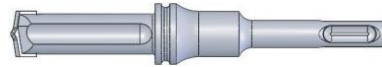

**Proton II SDS + Stop Drill**

SKU Model #	Drill bit diameter	Quantity	
		Box	Carton
554097	3/8"	1	20
554103	1/2"	1	20
554127	5/8"	1	20

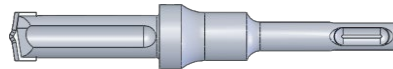

**Proton DI Proton Anchor**

SKU Model #	Anchor Rod size	Drill Bit Diameter	Bolt Threads	BodyLength	Thread length	Quantity	
						Box	Carton
554004	1/4"	3/8"	1/4"-20 UNC	1"	7/16"	100	2000
554011	3/8"	1/2"	3/8"-16 UNC	1-9/16"	5/8"	50	1000
554028	1/2"	5/8"	1/2"-13 UNC	2"	3/4"	50	500

